



**Congratulations on your purchase of a CHROMATEQ controller.**

Please read this manual carefully and thoroughly before using Chromateq SLIM 512 and SLIM 1024.

The information presented here provides a useful introduction to the wide range of features, settings and functions available in these compact and versatile devices.

This SLIM 512 and SLIM 1024 Technical Manual is written in English and French.  
(Le manuel technique des SLIM 512 et SLIM 1024 est rédigé en anglais et en français.)

All products and software are developed and designed in France.

CHROMATEQ SARL  
191 Allée de Lauzard  
34980 St Gély du Fesc  
FRANCE  
VAT: FR18521458034  
Siret: 52145803400027

Web & E-mail: [www.chromateq.com](http://www.chromateq.com)  
Phone: +33 952210755 / +86 13422062209

Whatsapp: +8613422062209  
Wechat: Chromateq  
QQ: 2908265661

Twitter: <https://twitter.com/Chromateq>  
Facebook: <https://www.facebook.com/ChromateqCompany/>  
YouTube: <https://www.youtube.com/c/chromateq>

-----  
**Copyright Information and Disclaimer**

Copyright © 2021 – CHROMATEQ. All rights reserved.

No part of this publication may be reproduced, distributed, or transmitted in any form or by any means, including photocopying, recording, or other electronic or mechanical methods, without the prior written permission of the publisher, except in the case of brief quotations embodied in critical reviews and certain other none commercial uses permitted by copyright law.

For permission requests, write to the publisher, addressed "Attention: Permissions Coordinator," at the address above.

**Trademark Credits**

Microsoft and Windows are U.S. registered trademarks of Microsoft Corporation. Art-Net™ – Designed by and Copyright Artistic License Holdings Ltd. All other products mentioned herein may be trademarks of their respective ® companies.

**Package Contents**

1x SLIM 512 or SLIM 1024  
1x USB cable  
1x download link for software and technical documentation

Please note: Check the package contents and the condition of the interface after unpacking! Contact your supplier if something is missing or damaged. Do not use the device if it seems to be damaged!
--

## SUMMARY

---

SUMMARY.....	3
INTRODUCTION.....	4
TECHNICAL SPECIFICATIONS.....	4
DEVICE FEATURES.....	4
SOFTWARE OPTIONS.....	5
BUTTONS AND CONNECTIVITY .....	5
Front and Side Panels .....	5
Rear Panel .....	5
BUTTON OPERATION AND LED DISPLAY MENU .....	6
Mode options.....	6
LED Display Menu Key .....	7
Clock and calendar Manual setting .....	7
USB CONNECTION (DRIVERS + CONNECTION) .....	8
Multiple USB connections (example system diagram using USB hub).....	8
STAND ALONE CONFIGURATION AND SETTINGS .....	9
Save scene in memory .....	9
Configuration options .....	9
STAND ALONE OPERATION .....	10
Reverting to Stand Alone mode.....	10
External Power supply and USB .....	10
Battery charging .....	10
Micro SD Card.....	10
Choosing Stand Alone modes .....	11
TRIGGER CONFIGURATION .....	12
Buttons .....	12
Clock and calendar .....	13
Dry contact .....	14
Contact commands.....	14
Infrared.....	15
Light Sensor.....	15
DMX in .....	16
OTHER ADVANCED TRIGGER OPTIONS.....	16
Scene recovery after power off .....	16
Time Trigger Priority.....	16
Play in Priority.....	17
ZONE SETTINGS AND CONFIGURATION .....	17
Editor mode .....	17
Standalone Mode.....	18
MASTER/SLAVE SETTINGS AND CONFIGURATION .....	18
Configuring Master/Slave interfaces.....	19
DMX MERGE CONFIGURATION .....	20
WALL MOUNTING INSTRUCTION .....	21
For Europe and Asia Standard: 60mm center to center distance.....	21
For America standard: 84mm center to center distance.....	21
PHYSICAL DIMENSIONS .....	22

## INTRODUCTION

---

SLIM 512 and 1024 are versatile multifunction lighting control interfaces.

- Suitable for live applications and fixed installations
- Hardware compatibility with Player, Pro and Studio DMX software
- SD card slot provides option to expand memory capacity
- DMX Splitter mode boosts reliability of DMX networks
- Wide choice of triggering methods

## TECHNICAL SPECIFICATIONS

---

Input	USB 2.0 via Mini USB
Number of DMX Outputs	Up to 512/1024 on 5 pins terminal screws
DMX Modes (512)	2x512 (Splitter, PC, Stand Alone) or 512 in/out (PC)
DMX Modes (1024)	2x512 ,1024 or 512 in/out (PC + Stand Alone)
Internal Memory	Yes, 4Mb (no SD card required)
Memory Capacity	20000 steps with 16 ch., 6000 steps with 512 ch., 3000 steps with 1024 ch.
External Memory	SD card slot (accepts FAT format, Class 6, 8 and 10, up to 256 GB)
Dimensions	H : 20mm(0.79in) / W : 128mm(5.04in) / D : 109mm (4.29in)
Net Weight (interface)	0.2 Kgs (0.44 lbs.)
Gross weight (package)	0.41 Kgs (0.9 lbs.)
Power Input	5V to 24V DC, 0.5A max on DC connectors, 5V, 0.5A via USB
Power / Consumption	0.3 ~ 0.5 W
CPU	32-bit processor
High Voltage Protection	Yes
Housing	Black or White with 4 mounting slots, ABS Plastic
IP rating	IP40
Operating environment	Indoor
Storage	Keep dry
Operating Temperature	- 30 à +85 C°
Certifications	CE, RoHS
International Warranty	Yes, 5 years
System Compatibility	Windows (7 and +), MAC OS X (10.6 and higher) and Linux (64 Bits, Debian, Redhat, Archlinux, Raspberry Pi)

## DEVICE FEATURES

---

DMX input (512)	PC only DMX record, DMX trigger
DMX Input (1024)	PC and Stand-Alone mode, DMX record, DMX trigger
Stand Alone Mode (512)	2x512 (splitter), fine DMX channels (16 bits)
Stand Alone Mode (1024)	2x512 (splitter), 1024, 512 in/out, fine DMX channels (16 bits)
Multiple Zone (1024 only)	5 Zones, play up to 5 scenes concurrently
Stand Alone DMX Merging	Yes, merge DMX lines and interfaces to play different Zones together
Real Time Clock - RTC	Time and calendar triggers (minutes, hours, week, days, month)
Trigger buttons	8 buttons with blue LED status display
Menu Buttons	4 buttons (Mode, Confirm, plus, minus)
Mode Menu	Scene and Page selection, Speed, Master Dimmer, Custom colours
Dry Contact Triggers	5 contacts port on 3,3V or 5V
Infra-red Receiver	External IR PCB and IR remote control available (optional)
Infra-red Options	10 scene selection, scene speed, master dimmer and next scene
Light intensity Triggers	External PCB with light sensor available (optional)
Master/Slave	Synchronize and connect up to 32 interfaces together in Stand Alone
Compatibility	8- and 16-bit DMX fixtures

## SOFTWARE OPTIONS

Player Software	512/1024 channels DMX + Stand Alone mode, Live Board mode
Studio DMX 3D viewer	Full Mode
Pro Software	512/1024 channels, normal mode, 30-minute loop of Audio and Video Timeline
Art-Net output from PC	1 or 2 Universes (DMX + ArtNet)
Wi-Light 2 App	Control Player, Pro or Pixel Mapping software over local WiFi network
Free software updates	Yes

## BUTTONS AND CONNECTIVITY

### Front and Side Panels

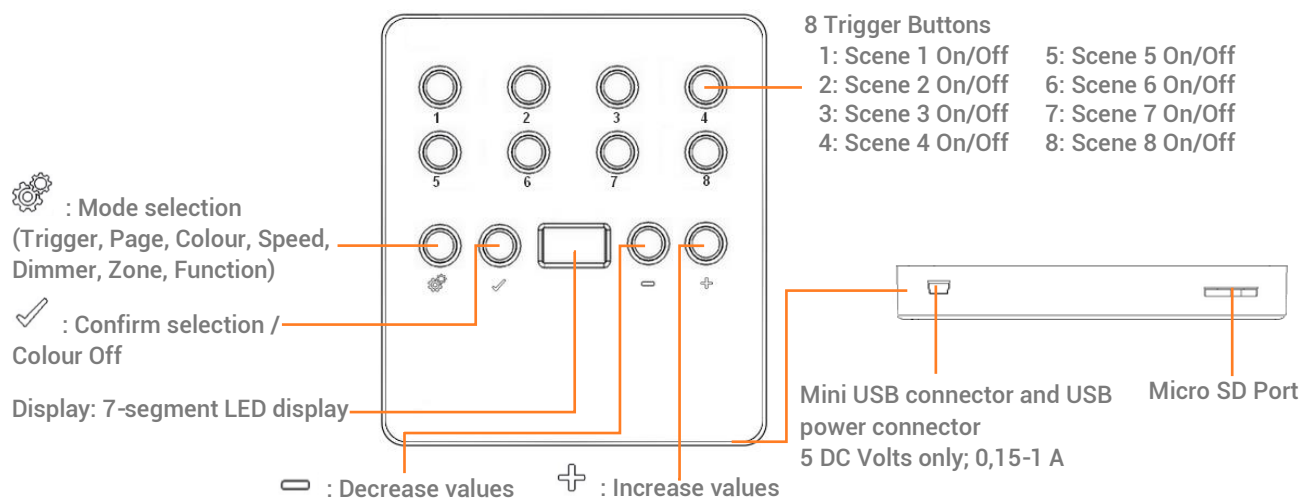

### Rear Panel

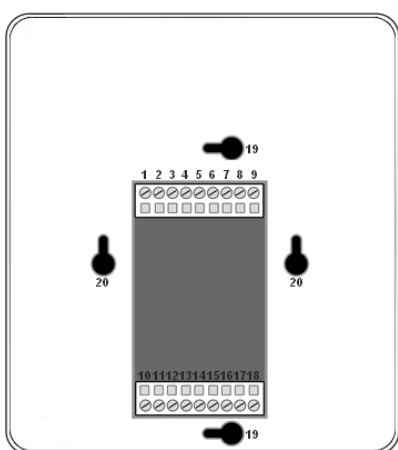

#### External connectors:

- 1: External input power 9-36V
- 2: GND
- 3: External trigger A
- 4: External trigger B
- 5: External trigger C
- 6: External trigger D
- 7: External trigger E
- 8: Master/Slave Data
- 9: Master/Slave Clock
- 10: 5V. DC External trigger voltage
- 11: GND
- 12: Infra Red signal
- 13: Light Sensor
- 14: DMX2 - data
- 15: DMX2 + data
- 16: DMX Ground
- 17: DMX1 - data
- 18: DMX1 + data

#### External wall mounting:

- 19: America standards
- 20: Europe + Asia standards

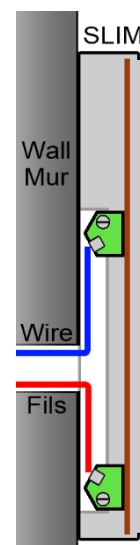

## BUTTON OPERATION AND LED DISPLAY MENU

---

### Mode selection button

Press the  button to select one of the available modes: Scene triggers (SA), Page (PA), Colour (Co), Speed (SP), Dimmer mode (dl) or zone selection (Zo).

### Confirm Button

When navigating Mode menu, press the  button to confirm values or to turn off the current colour selection.

### Next/Previous (Up/Down) +/- buttons

Press + or – buttons to navigate the Mode menu

### Blue LED buttons

In SA Scene or Page mode, push one of the 8 trigger buttons to play a scene from memory.

Push the button again to stop the scene.

In Colour mode, push a trigger button to select (start) a custom colour. Push again to stop.

## Mode options

Scene trigger mode "SA": Select the desired scene using the + or – buttons, then press Confirm to play the selected scene (01 to 255). The scene number will flash several times to confirm your selection.

Scene "00" indicates that no scene is playing.

Page Mode "PA": Select the desired page using the + or – buttons (P0 to P9), then choose an available scene in the selected page using the 8 trigger buttons. Then the number of the selected scene will be display on the LED display.

Colour mode "Co": Using the 8 trigger buttons, select one of the 8 custom colours. Or, choose a colour from the colour wheel using the + or – buttons to select from 00 to 99. Press the Confirm button to turn off the current colour or to recall the last colour from the colour wheel.

Speed Mode "SP": Increase or decrease the Speed of the current scene using the + or – buttons.



Values range from -9 to +9.

Dimmer Mode "dl": Increase or decrease the general intensity (dimmer and/or RGB channels) of scenes and colours with + or – buttons. Values range from -9 to +9.

Zone Mode "Zo": Select the zone using the + or – buttons (Zone A ~ E and global Zone), then choose an available scene in the selected zone using the 8 trigger buttons or pages.

## LED Display Menu Key

The LED Display shows the current scene, zone, page, colour, operating mode, speed, dimmer and firmware update mode. The displayed values vary according to the selected mode.

On	-	The interface is powered On and is not running any show from memory.
PC	-	The interface is connected to a computer and communicating with the software. In this mode, the interface is under software control.
Sd	-	Inserted SD card is properly detected and the interface is playing the show file from the Sd card.
SA	-	Scene trigger mode. In this mode, the LED display shows the current scene number (from 01 to 511). By default, when no scene is playing, all DMX channels are set to 0. "00" indicates Blackout and the interface sends nulls (0x00) on all DMX channels.
PA	-	Page mode. There are 10 pages of 8 scene, it is about 80 scenes maximum to be triggered. The display indicates the page number from P0 to P9. In this mode, use the 8 trigger buttons play the scenes stored in the selected page.
Co	-	Colour mode. The display indicates the selected custom colour number (from C1 to C8). Or the colour value applied from the colour wheel.
SP	-	Speed mode. Increase or decrease the current scene speed. The display indicates the speed of the current scene from -9 to 9.
dl	-	Dimmer mode. Increase or decrease light output of scenes and custom colours. The display indicates the general intensity from -9 to 9.
Pr	-	Programming memory Mode. Pr is displayed when the interface is writing a show to memory.
Zo	-	Zone mode. After programming the interface memory, Zone A is selected by default. In this mode, the LED display shows the current Zone: Global, A, B, C, D, E. Zone A to D display: 
		Global Zone display: 
		The display switches between the current zone and the running scene number every 3 seconds. Use + or - to navigate between zones. Scene buttons may be pressed to instantly trigger scenes without entering in the zone with the  button.
YE	-	Year setting in the clock setting mode.
Mo	-	Month setting in the clock setting mode.
dA	-	Day setting in the clock setting mode.
ho	-	Hour setting in the clock setting mode.
Mi	-	Minute setting in the clock setting mode.
CL	-	Confirmation of the new clock setting.
bL	-	Updating firmware mode. Displayed when a new firmware is being written to memory. The display will flash during the firmware update. Do not disconnect the interface in this mode.
Fi	-	File Problem in the SD card: No show File save on the SD card or wrong File name (sdcardshowv2.sdq) or show file corrupted or empty SD Card detected or wrong memory format.

## Clock and calendar Manual setting

It is possible to setup the internal interface clock and change or update its date and time manually.

To access the clock mode, hold the "+" and "-" buttons for 5 seconds.

"YE" shows the current year setting.

Use the + and - buttons to select the correct year and confirm by pressing the  button.

Repeat this procedure to set month (Mo), day (dA), hour (ho) and minutes (Mi).

After confirming the minutes, "CL" will blink to confirm that the new configuration is saved to memory.

The interface clock is now calibrated to your new setting.

This function is useful for setting the interface clock directly on site and without the use of a computer.

## USB CONNECTION (DRIVERS + CONNECTION)

After installing the control software and the USB drivers, use the USB cable to connect the interface to the computer.

Windows drivers installation: Before opening the software for the first time, it is possible to check that the drivers were properly installed during the software installation:

Go to the device manager and check that this icon is visible under « Universal Serial Bus controllers»:

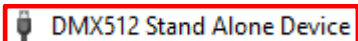

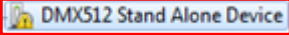
If there is a warning icon on the DMX512 Stand Alone Device  the drivers will require manual installation.

Mac and Linux drivers are automatically installed. In Mac OS, check the « USB device tree ». In Linux, use the command « lsusb » to check if the « DMX 512 Stand Alone device » line is visible.

Once connected, start the software and select "USB". All connected interfaces will be detected and displayed in the list. Uncheck any interfaces that are not needed.

### Multiple USB connections (example system diagram using USB hub)

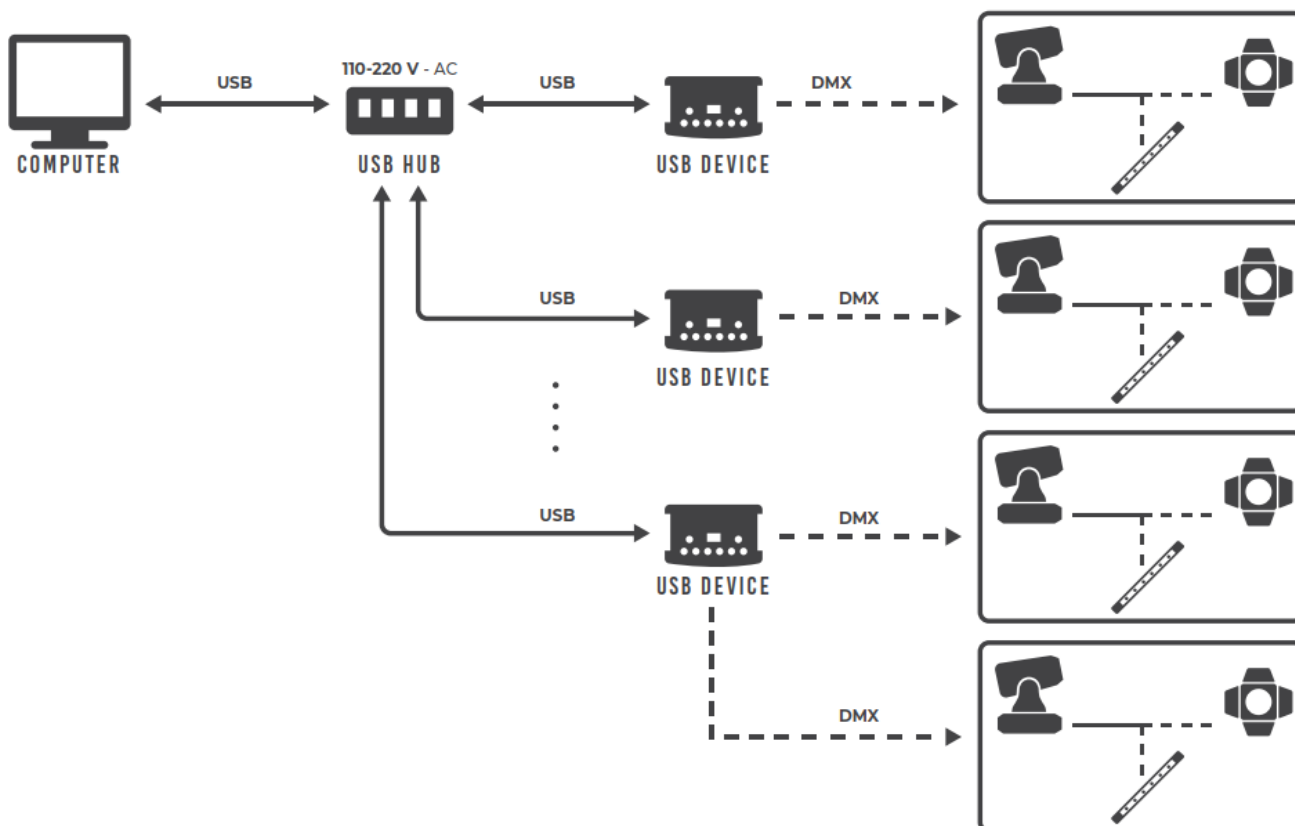



## STAND ALONE CONFIGURATION AND SETTINGS

### Save scene in memory

In the Stand-Alone mode of the control software, drag and drop a scene from the open project's scene list to the list of scenes to be written to the interface's memory. Adding a trigger action (LED Button, Contact, IR remote, DMX In, Repeat Time and Start Time) will automatically transfer the selected scene into the list of scenes to be written into the memory.

Click to Save in Memory button and select the desired option (Save in Memory by default)

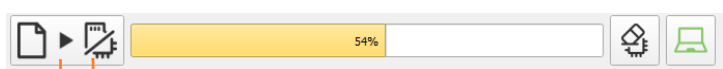

Save in memory

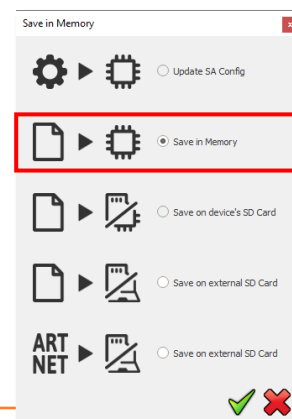

### Configuration options

#### IN/OUT Config tab

Change the configuration of the interface's DMX I/O when using 2 DMX universe devices. Trigger scenes via the DMX signal from an external DMX controller. Map the software's DMX universes to the interface outputs in order to optimise the memory storage capacity of the controller in Stand Alone mode. Manually choose the number of active channels for each DMX universe.

#### Clock tab

Displays the time and date of the selected interface from the list. Modify the time and date (minutes, hours, days, months and years). Synchronize the interface clock using the current computer time and date by selecting the option: Set Current Date and Time.

#### Options tab

Turn off the LED display after 4 seconds of inactivity. Select a default scene to play automatically after powering up the interface (with USB or external power supply). Note: the selected default start scene loses priority if another scene has the option "restore if power off".

When the Merge In/Out option is activated, the input from Line B (DMX-B) is analysed and combined with the interface output A (DMX-A), such that both DMX streams are merged in real time.

Configure the "Select dimmer channels" option to choose Dimmer or RGBW channels separately to be controlled directly by a dimmer button or dry contacts.

#### Master / Slave tab

Select the Master/Slave mode when using multiple interfaces in order to synchronize their standalone mode. Refer to each interface datasheet to understand the possible configurations.

#### Triggers tab

Select a contact for each action: Dimmer +, Dimmer -, Blackout, Speed +, Speed -, Pause, Scene +, Scene - and Area.

#### Zone Tab

Displays a summary of the Zone DMX configuration and the associated DMX addresses.

## STAND ALONE OPERATION

### Reverting to Stand Alone mode

The interface enters Stand Alone mode within 5 seconds of powering on if no control software connection is detected.

### External Power supply and USB

The external power supply is used only for Stand Alone mode. If a USB cable is connected to the interface when operating in Stand Alone mode, the device will reboot to detect a computer connection. Any scenes playing in Stand Alone mode will stop when the USB cable is connected.

### Battery charging

Before deploying the interface in Stand Alone mode, connect the interface for 1 hour in order to charge the clock battery and to avoid losing saved configurations.

### Micro SD Card

Shows can be saved to a micro-SD card installed in the interface's SD card slot or connected to the computer. The card must be CLASS 10, formatted as FAT or FAT 32, with a maximum capacity of 256 GB.

SD Card connected to computer: in Stand Alone mode, click Save to Memory, then select Save on external SD Card. Save to the root directory of the SD card.

SD Card installed in the interface: select Save on device's SD Card.

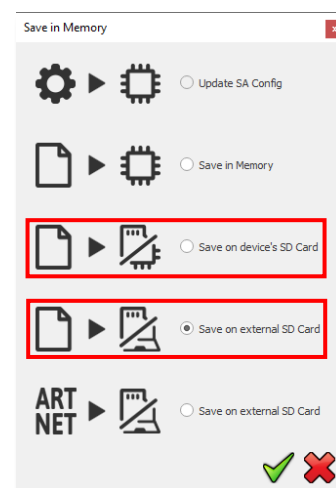
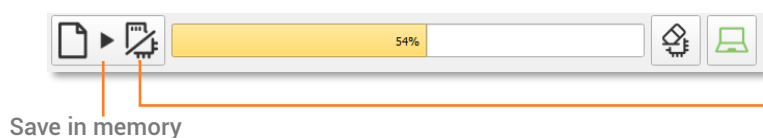

To play the SD show in Stand Alone, insert the card into the interface's micro-SD slot. When the card is booted, the display will show "Sd" to indicate that the SD show is playing.

Note: the show file must be saved to the micro-SD root directory. It will not play if the file is renamed or saved to a folder or subdirectory.

#### Notes regarding recommended SD card specifications:

The class of the SD card indicates its read/write speed. Higher class numbers (e.g., class 10) offer faster speed and a better compatibility.

Class 6 or higher is preferred for optimal system performance. Older SD cards of type class 2 and 4 may not work. Choose class 10 micro-SD cards for mobile phones.

## Choosing Stand Alone modes

It is possible to customize the interface according to the modes used in Stand Alone.

Drag and drop mode icons to arrange their order. Right click to Add or Remove a mode.

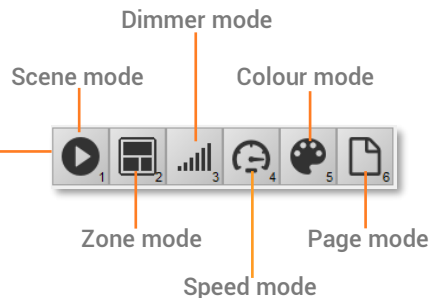
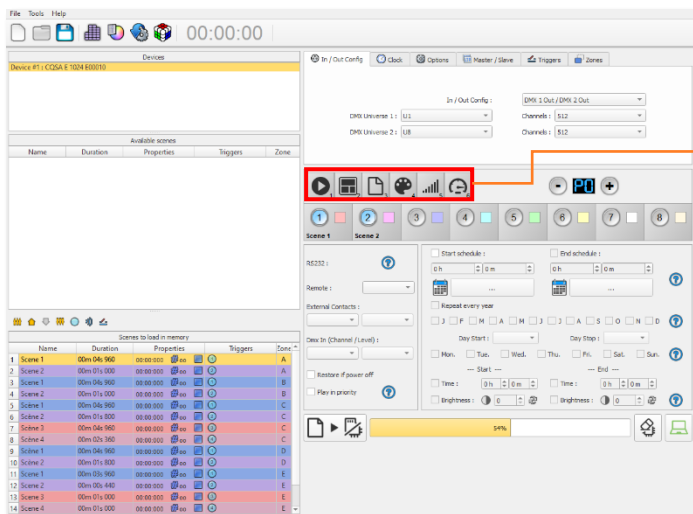

Drag and Drop to organize mode



Right click on a mode to remove it



Click on + to add a mode

You can also choose a single menu to simplify the use of the interface.

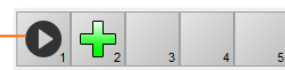

## TRIGGER CONFIGURATION

The software's Stand-Alone mode enables configuration and customization of all triggers.

Configuration information is saved to the interface with the memory writing function.

### Buttons

Stand Alone mode offers 8 graphical buttons that represent the interface's 8 physical LED buttons.

From the scene list in Stand Alone mode, drag and drop a scene on any button to assign a button number.

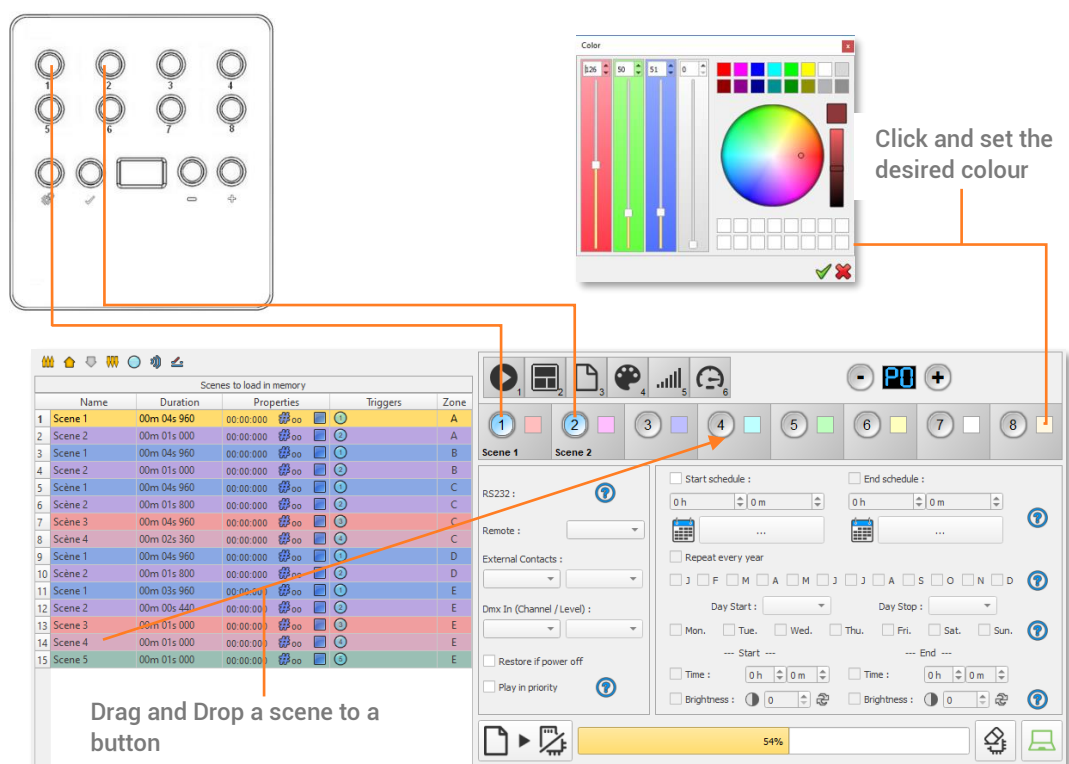

It is possible to replace a scene by another one or to remove a scene by pulling it out of the list.

Custom colours can be assigned to each button for playback in Colour mode by clicking on the square colour icon next to the graphical button and selecting the desired colour with sliders, wheel or swatches.

## Clock and calendar

Stand Alone mode includes an internal clock and calendar. Time triggers can be assigned to every scene in the scene list. (255 max)

Start and end schedules can be programmed according to calendar dates, hours and minutes, and further defined by days of the week, enabling fully-automated scheduled playback.

### CASE 1: Programming a unique trigger:

Start schedule: A single instance of the scene triggered at the given date and time

Start schedule : 16 h 30 m  
06.08.2015

End schedule: The scene stops at the given date and time.

End schedule : 16 h 31 m  
06.08.2015

### CASE 2: Programming a repeating trigger:

Start schedule: effective Date from which the scene will be playable according to the programmed triggers

Start schedule : 16 h 30 m  
06.08.2015

End schedule: Date after which triggers will be ignored. With no End date, triggers will run continuously

End schedule : 16 h 31 m  
06.08.2015

Repeat months, list of the months of the year

J  F  M  A  M  J  J  A  S  O  N  D

The 12 check boxes represent the 12 months of the year (J) January to (D) December. The triggers will be performed on the selected months. Next, a daily hour range must be defined to each month.

Start and Stop days

Day Start : 01 Day Stop : 15

With a monthly repetition, starting and stopping days for each chosen month can be selected. In this example, triggers are performed between the 1<sup>st</sup> and the 15<sup>th</sup> of each chosen month.

List of the days of the week

Mon.  Tue.  Wed.  Thu.  Fri.  Sat.  Sun.

The check boxes represent the 7 days in a week. The triggers will be performed on the selected days only. Next, a time range must be defined.

Start time: Determines the daily start time when the scene will be triggered on each chosen day, according to the schedule of chosen months, days of the week, and start and end dates.

Release time: Determines the daily stop time when the scene will be stopped on each chosen day (following the schedule of chosen months, days of the week, and start and end dates). Setting the release time is optional. If not defined, the scene will keep playing until another trigger event happens (e.g., the triggering of another scene).

Start Time : 11 h 30 m

Release Time : 18 h 0 m

NOTE: For a daily repetition, if the start time is later than the release time, the triggering will stop the next day, even if the next day has not been selected.

## Dry contact

The 5 external contacts are located on the screw terminal. The 5 dry contacts can be used to trigger 5 scenes via external relay. Adding more than 5 triggers requires a multiplexed system (for a maximum of 31 contacts maximum).

External Contact Closures can be done only when Pins 3, 4, 5, 6, 7 are connected to Pin 10 corresponding to the 5V DC of the interface (It is also possible to connect the contacts to 5V DC or 3V3 DC).

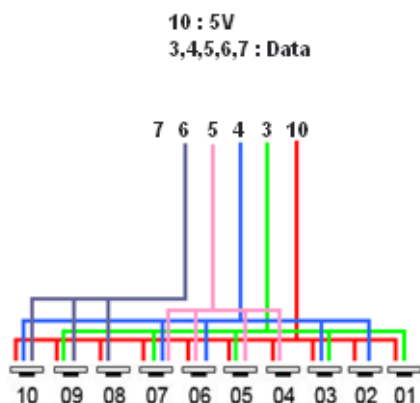
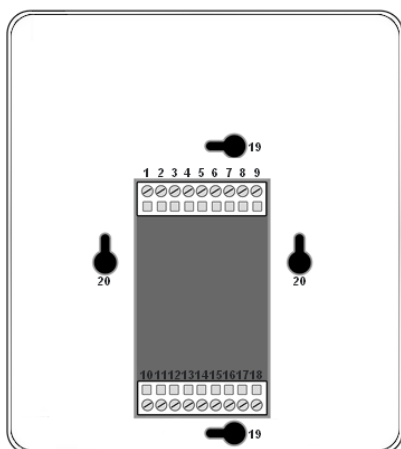

Pin Table :

- Trigger 01 = Pin 3
- Trigger 02 = Pin 4
- Trigger 03 = Pin 3 + 4
- Trigger 04 = Pin 5
- Trigger 05 = Pin 3 + 5
- Trigger 06 = Pin 4 + 5
- Trigger 07 = Pin 3 + 4 + 5
- Trigger 08 = Pin 6
- Etc...

By selecting a scene in the list, it's possible to choose the external contact number (from 01 to 31) to trigger the scene.

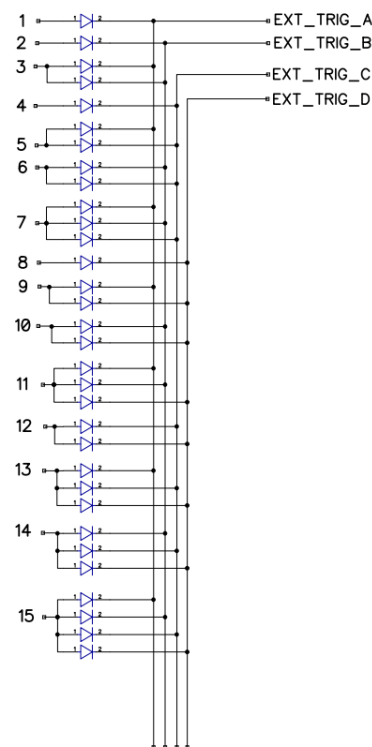
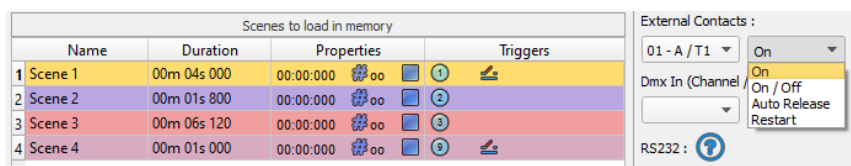

Several trigger options are available for external contact triggers:

**On:** Activating the contact plays the scene (only trigger action is to start the scene).

**On/Off:** Activating the contact starts the scene, subsequent activation stops the scene. Each trigger action will invert the state of the scene (start/stop).

**Auto Release:** The scene plays while the contact is activated. When the contact is released, the scene stops.

**Restart:** If the scene is playing, activating the contact will restart the scene from its beginning. If the scene is not playing, then it will start.

Dry contact reaction time: 8 ms (0.008 s) / Time between 2 contacts: 500 ms (0.5 s)

## Contact commands

External contacts can also trigger commands in Stand Alone mode.

From the Triggers tab you can select a contact for each action:

Dimmer +, Dimmer -, Blackout, Speed +, Speed -, Pause, Scene +, Scene - and Area.

**Note:** It is not possible to use the same trigger for scene and command. In this case, the scene contact has the priority or the scene will lose its contact trigger information after choosing the contact from the Trigger command tab.

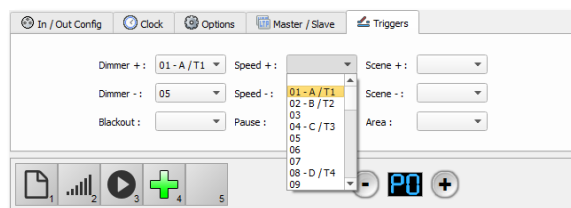

## Infrared



To use the optional IR remote control, an external PCB with an IR receiver must be connected to the screw terminal of the Stand-Alone interface. (Pins 10,11,12 The maximum cable distance to the receiver is approx. 20 meters.

Button 1 to 10 must be assigned to a scene via the software. Each button triggers a different scene. With the remote control, a scene cannot be stopped directly with the assigned button. To stop a scene, press the Black Out (Stop) button or trigger another scene.

Pause button freezes the current scene in its current state. Black Out button stops the current scene and plays the empty scene number 00. All DMX channel levels are set to zero.

+/- for scene trigger: Selects the next or previous scene automatically. No need to hold the button to confirm and play a scene. The next or previous scene will play directly after selected.

+/- for Scene speed: Increases or decreases the speed of the current scene. A different speed can be chosen separately for each scene.

+/- for Master dimmer: Increases or decreases the RGB, CMY and dimmer channels of the fixtures. The CMY, RGB, Dimmer channels are defined in the Profile of the fixture and the stand-alone mode.

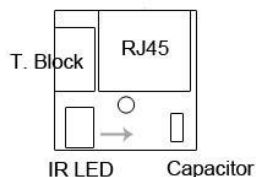

IR PCB Pin assignment:

-With RJ45 use pins: #8 = Ground; #4 = IR Data; #7 = 5V DC.

-With T. Block use pins: 4 = IR Data; 7 = 5V DC; 8 = Ground.

To assign a remote button to a scene: in the software go to Stand Alone Mode and use the Triggers options. Stand Alone mode offers up to 10 triggers with the Infrared remote.

By selecting a scene in the list, it's possible to choose the remote button number (from 01 to 10) to trigger the scene.

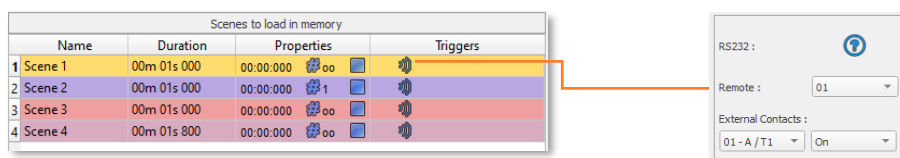

## Light Sensor

The light sensor function works only with Time triggers. The external PCB must be connected to the screw terminal and the light sensitivity defined in the software.

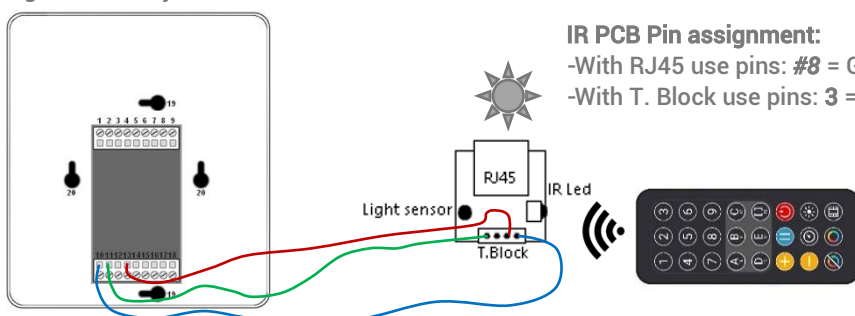

IR PCB Pin assignment:

-With RJ45 use pins: #8 = Ground; #3 = Light Data; #7 = 5V DC.

-With T. Block use pins: 3 = IR Data; 7 = 5V DC; 8 = Ground.

## DMX in

Stand Alone mode offers up to 512 DMX IN channel triggers and up to 255 DMX trigger values per channel. This enables triggering scenes directly from an external DMX source.

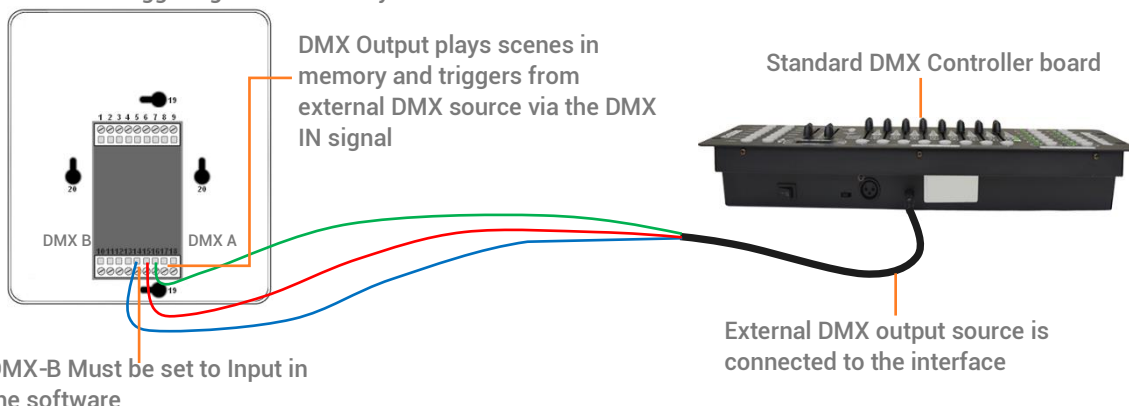

In Stand Alone window, set In / Out Config as DMX 1 Out/DMX 2 In, and select the DMX Out universe

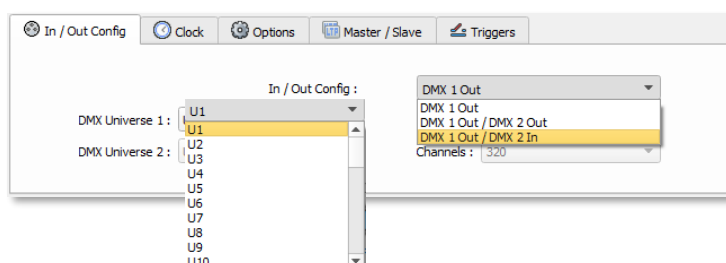

By selecting a scene in the list, it's possible to choose the channel number and the DMX value to trigger the scene. The scene will play when the DMX channel value is reached or exceeded.



## OTHER ADVANCED TRIGGER OPTIONS

### Scene recovery after power off

The interface can recall the last scene played before power is cut off, and recover that scene when the power is restored.

Each scene has the option to select "Restore if power off"  
This option will take priority over the default start scene.

Click to enable the option

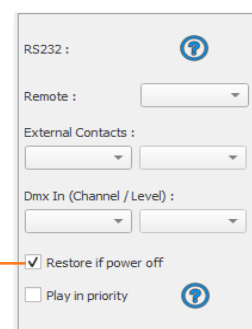

### Time Trigger Priority

If several scenes share an identical time trigger (same date: hour: minute), only the last scene in the list will be triggered, and the other scenes will be ignored.



## Play in Priority

The “Play in Priority” option allows scene playback that ignores all other triggers (except for touch button and scheduled clock triggers), allowing the scene to play completely to its end without interruption.

Click to enable the Play in priority option:

The scene will keep playing. No other triggers will be allowed (contacts, Infrared, DMX) while the scene is playing (except Time/calendar schedules and buttons)

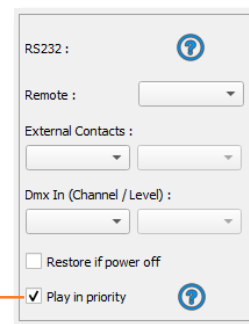

## ZONE SETTINGS AND CONFIGURATION

The interface has the capability to play 1 scene per zone and up to 5 zones at the same time in Stand Alone mode.

It is possible to extend the last zone over several universes using a Master / Slave daisy chain of multiple interfaces. The Master interface stores all five zones in memory and its last zone drives the Slave interfaces, which only have the last zone in memory.

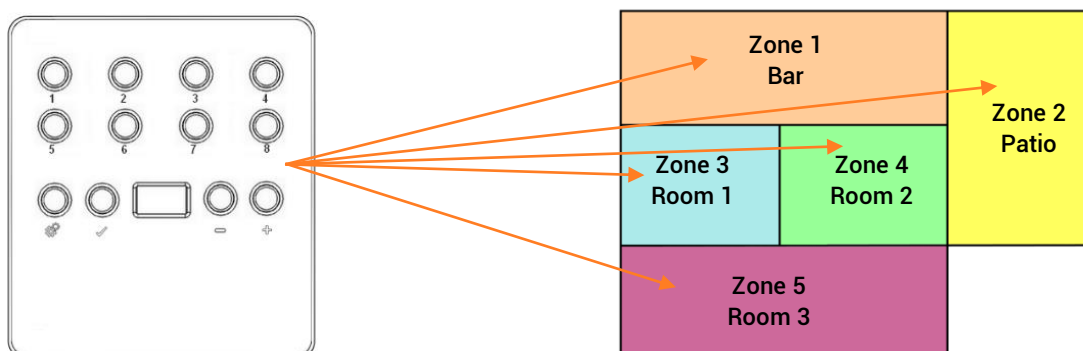

## Editor mode

In the zone window, move the central bar to define the zone parameters. It is also possible to manually choose the zone range in the fields.

Note: Make sure the DMX Patch and fixture addresses correspond to the defined Zones.

Click on + to add zones

The zone window can be displayed by clicking on the « Zone » button

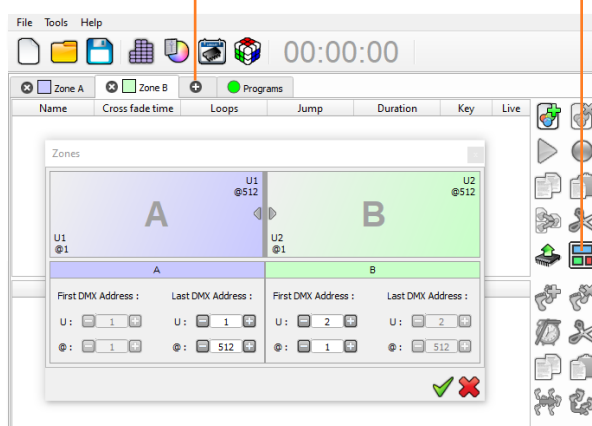

Once zones are defined, create scenes in the corresponding tab:

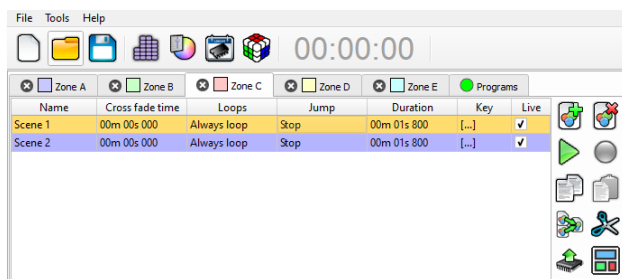

### Standalone Mode

The Zone option can be configured in Standalone mode (manual Zone selection to enable or not the mode in the stand-alone menus)

The « Zones » tab allows to display and configure each zone (double click on a zone to edit)

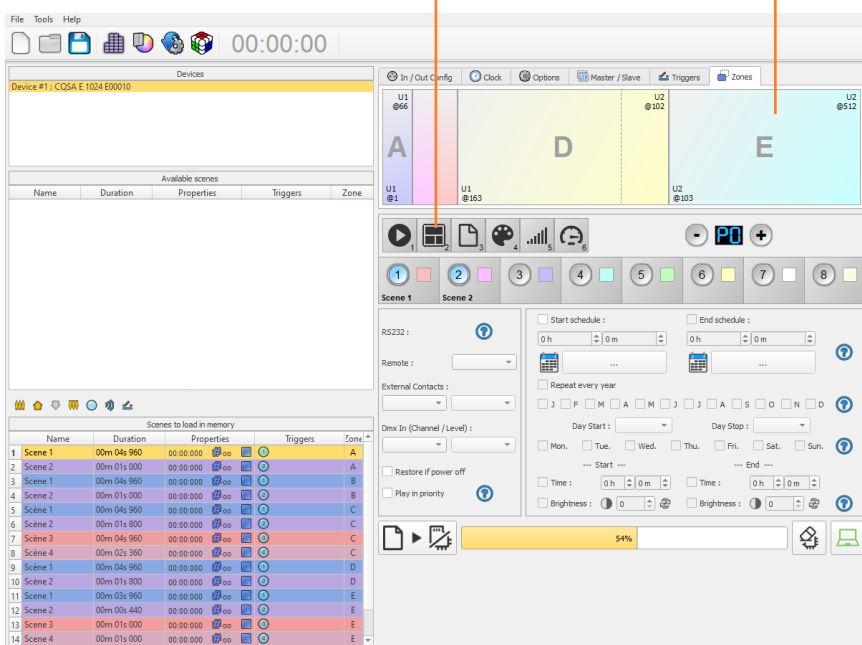

### MASTER/SLAVE SETTINGS AND CONFIGURATION

Cable Master / Slave (up to 32 interfaces).

When multiple interfaces are connected with USB, the Stand-Alone mode allows to set them as Master/Slave. This mode synchronises many interfaces and mutualizes their Stand-Alone spaces, combining the universes.

Here is an example of wiring 3 interfaces connected as Master/Slave:

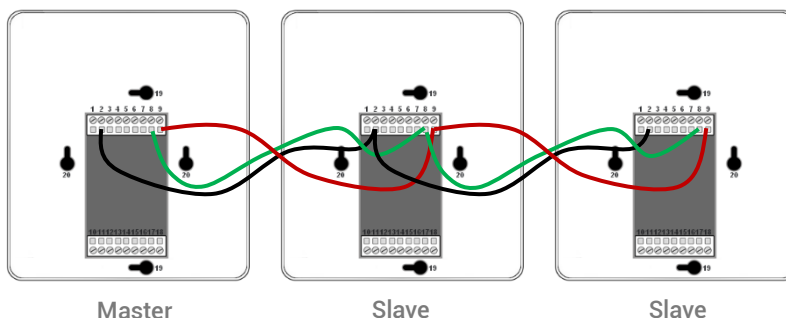

## Configuring Master/Slave interfaces

When one interface is defined as master in the software, the other interfaces are automatically set to slave mode. There are four different modes of master/slave interaction: Default, Desynchronized, LTP and No Release.

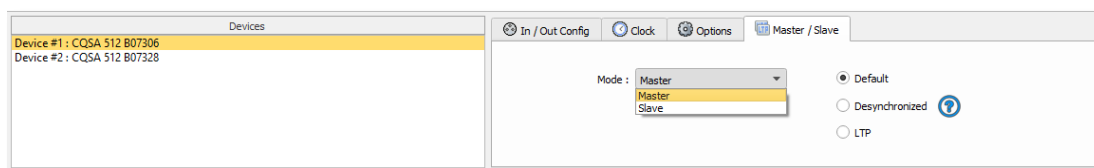

### MODE MASTER/SLAVE « Default »

A single interface is defined as master (lower serial number by default), with others automatically set to slaves. The master device plays the current scene and synchronizes the slave interfaces. The master forces the slave interfaces to play the same scene and the same step at the same time. The slave interfaces are forced to follow the master timings and triggers and they cannot act, play or trigger a scene independently. Master can trigger on and trigger off scenes of the slave interfaces.

### MODE MASTER/SLAVE « Desynchronized »

An interface can be defined as master, others are automatically set to slaves. All Triggers On or Off operated on the master interface are effective to slave ones. However, slave interfaces are not synchronized with master interface timing and retain individual control. Consequently, slaves can trigger and play different scenes at any time and not synchronized with the master ones. The master acts like a general remote imposing triggering to the slaves with total priority. Master can trigger ON and trigger OFF scenes of the slave interface.

### MODE MASTER/SLAVE « LTP »

LTP means Latest Takes Priority. All interfaces are defined as slaves. Interfaces are not synchronized with timing and can trigger and play different scenes by itself. However, triggers from an interface are passed to the other connected interfaces automatically and slave interfaces are forced to trigger the same scene. In this mode, each interface acts like a general remote imposing triggering to the other slaves without synchronization.

### THE «NO RELEASE» Option

This option is only available with LTP or DESYNCHRONIZED modes. Only triggers ON from the master interface are executed and effective. All triggers OFF are ignored and slave interfaces keep playing their current scene. Each Slave interface can choose to release or not its scene depending on if the option is activated or not.

## DMX MERGE CONFIGURATION

One DMX port must be turned into an input to capture the DMX signal provided by another DMX source. The interface will merge the incoming signal with its own output signal by comparing the DMX levels with an HTP filter (priority on the highest levels of the signals). Merging is a solution to keep manual control of channels when using a DMX board, for example. It's also a method to create a multi-zone system by merging several interfaces on one final DMX line. In this last case, each interface can play a scene dedicated to the fixtures at the same time and on the same DMX line.

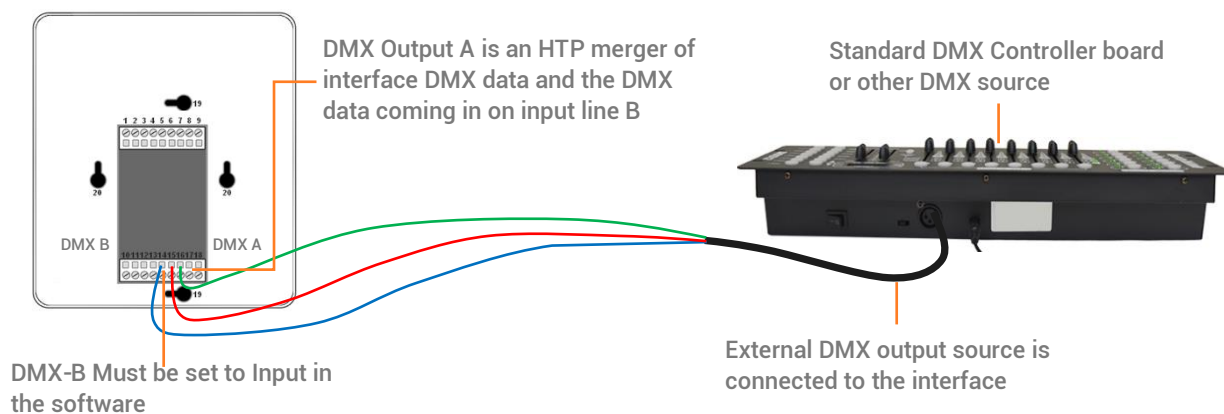

In the software's standalone window, select: "DMX 1 OUT / DMX 2 IN" and confirm the merge option

## WALL MOUNTING INSTRUCTION

The SLIM interface can be wall mounted on any place and surface.

Wires are connected to the screw terminal block located on back of the SLIM housing. To fix the SLIM housing to a Europe, Asia or America standard wall switch box, there are 4 holes located behind the housing.

Follow the mounting instruction to proceed.

### For Europe and Asia Standard: 60mm center to center distance.

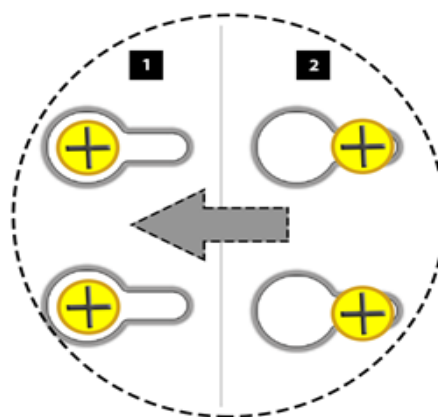
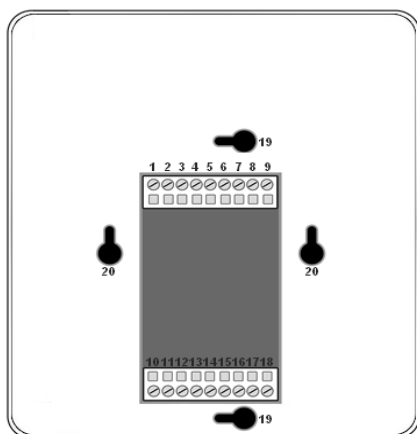

- 1- Insert the screws in the hole (vertical axis for US wall boxes, horizontal axis for others) , adjust the screw position to hold well the housing.
- 2- Slide the housing to lock the screw in the slots

### For America standard: 84mm center to center distance.

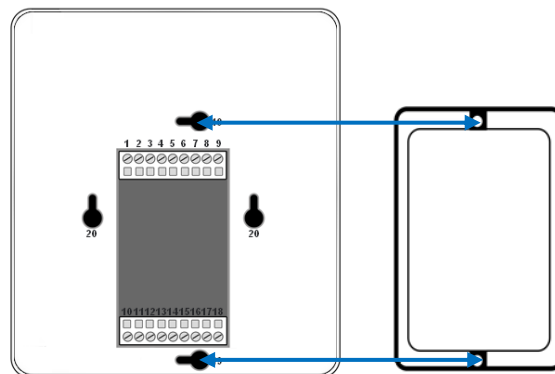
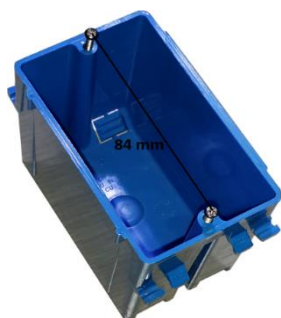

Use the screws of the wall switch box to hold the SLIM

## PHYSICAL DIMENSIONS

Metric unit measurements in mm.

Rear panel

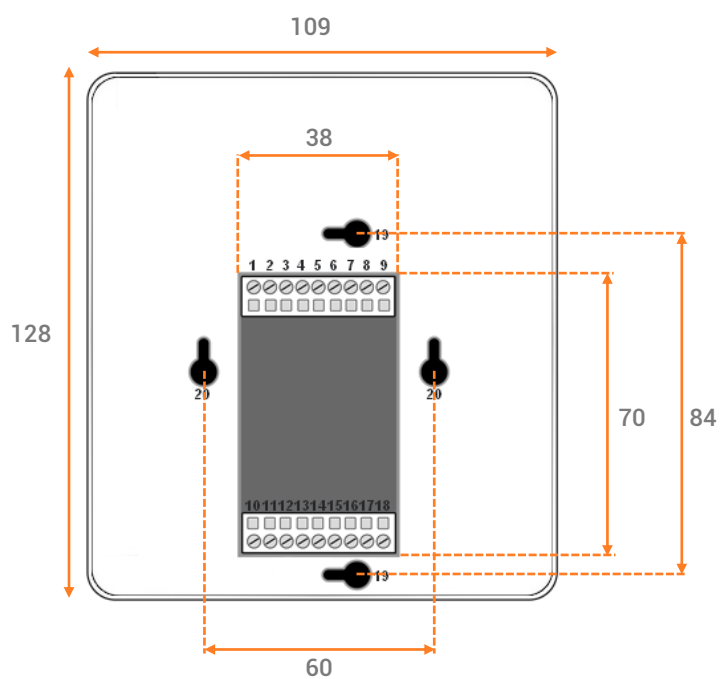

Side panels



Bottom panel

